

NCP5030MTTXGEVB

NCP5030 High Power Lighting Evaluation Board User's Manual



ON Semiconductor®

<http://onsemi.com>

EVAL BOARD USER'S MANUAL

Overview

The NCP5030 is a fixed frequency PWM buck-boost converter optimized for constant current applications such as driving high-powered white LED. The buck-boost is implemented in an H-bridge topology and has an adaptive architecture where it operates in one of three modes: boost, buck-boost, or buck depending on the input and load condition. This device has been designed with high-efficiency for use in portable applications and is capable of driving up to 1.2 A pulse current and 900 mA continuous current into a high power LED for camera flash, flashlight, torch and similar applications. To protect the device cycle by cycle current limiting and a thermal shutdown circuit have been incorporated as well as output

OVP (Over-Voltage Protection). The high switching frequency allows the use of a low value 4.7 μ H inductor and ceramic capacitors. The NCP5030 is in a low profile and efficient thermally enhanced 3 x 4 mm DFN package.

NCP5030 High Power Lighting Evaluation Board

This evaluation board demonstrates the overall NCP5030 capabilities and offers very easy current programming. The output current is fully configurable via the usage of 4 external resistors and corresponding jumper headers. The NCP5030 lighting evaluation board schematic is depicted in Figure 2.

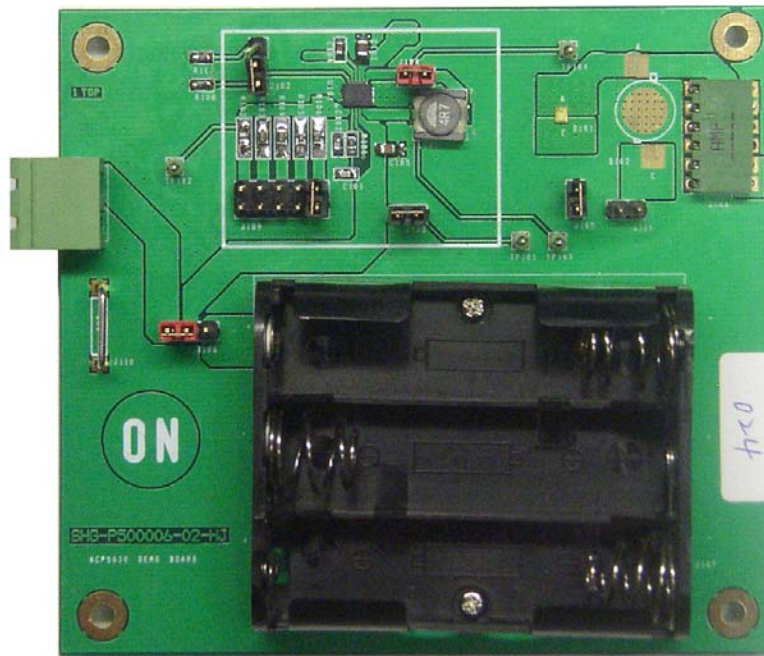

Figure 1. NCP5030MTTXGEVB Board Picture

NCP5030MTTXGEVB

SCHEMATIC

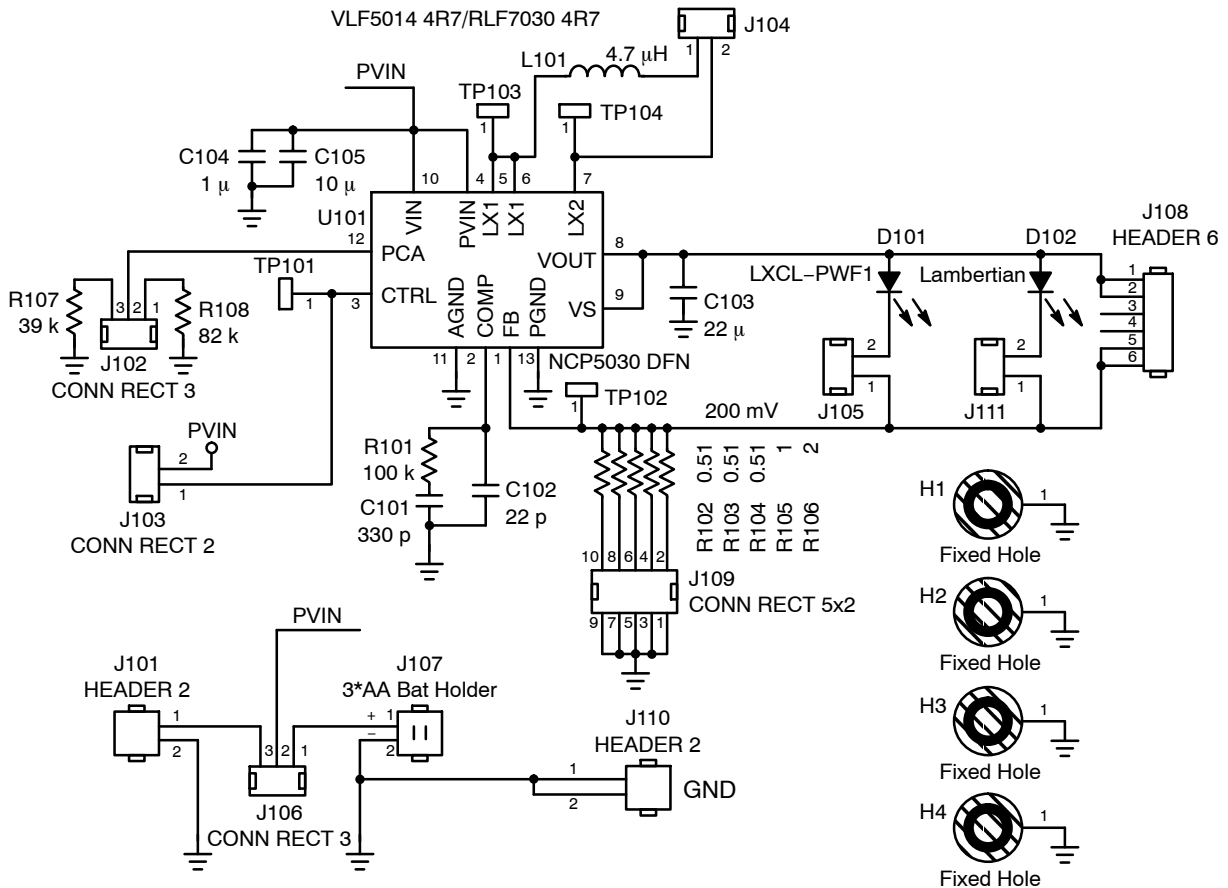

Figure 2. NCP5030 High Power Lighting Evaluation Board Schematic

Operation

L101 selection depends on the output current, VLF5014A4R7M1R1 is recommended at output current under 500 mA, and RLF7030T4R7M3R4 is recommended when output current is larger than 700 mA.

The power supply of NCP5030 should be from 2.7 V to 5.5 V. Maximum input voltage is 7.0 V and maximum continuous output current is 900 mA.

CAUTION:

1. Exceeding the maximum input voltage may damage NCP5030 permanently!
2. Too long time duration at over output current may decrease LED life time or even damage LED!

Table 1. Input Power Connector

Symbol	Descriptions
J101-1	Positive terminal of external power supply
J101-2	GND of external power supply
J107-1	Positive terminal of 3*AA batteries in serial
J107-2	GND of 3*AA batteries in serial

Table 2. Output Power Connector

J108-1/2	VOUT of NCP5030
J108-5/6	FB of NCP5030

NCP5030MTTXGEVB

Table 3. Jumper Setup

Symbol	Descriptions
J102-1/2	Peak current set to about 3 A, peak current and setting resistor selection can reference the datasheet of NCP5030
J102-2/3	Peak current set to about 1.5 A, peak current and setting resistor selection can reference the datasheet of NCP5030
J103	Short will connect CTRL to PVIN and enable NCP5030
J110	GND test jumper
J104	Must be connected to ensure NCP5030 work properly, can measure inductor current here, such as peak current of inductor
J105	Select D101 as load of NCP5030, be careful if J111 or J108 is connected
J111	Select D102 as load of NCP5030, be careful if J105 or J108 is connected
J109	Output current setting, reference to table 5(Output current setting table)

Table 4. Test Points

TP101	CTRL and enable of NCP5030.
TP102	FB, feedback, reference voltage is 200 mV.
TP103	Switch LX1
TP104	Switch LX2

Current Setting Selection

The output is determined by the resistor or resistors connected between FB pin and GND. R102 to R106 and J109 are used for output current setting according to eq. 1:

$$I_{out}(A) = \frac{0.2}{R(\Omega)} \quad (\text{eq. 1})$$

Where R is the total resistance between FB and GND, J109 allows parallel connections of several resistors to select output current.

Following is the output current setting table of J109 (1 = short connected; 0 = left open)

Table 5. Output Current Setting Table

PIN9-10	PIN7-8	PIN5-6	PIN3-4	PIN1-2	Output Current (mA)
0	0	0	0	1	100
0	0	0	1	0	200
0	0	0	1	1	300
0	0	1	0	0	400
0	0	1	0	1	500
0	0	1	1	0	600
0	0	1	1	1	700
0	1	1	0	0	800
0	1	1	0	1	900

NCP5030MTTXGEVB

Efficiency Test

Figure 3 and Figure 4 describe efficiency results in different conditions.

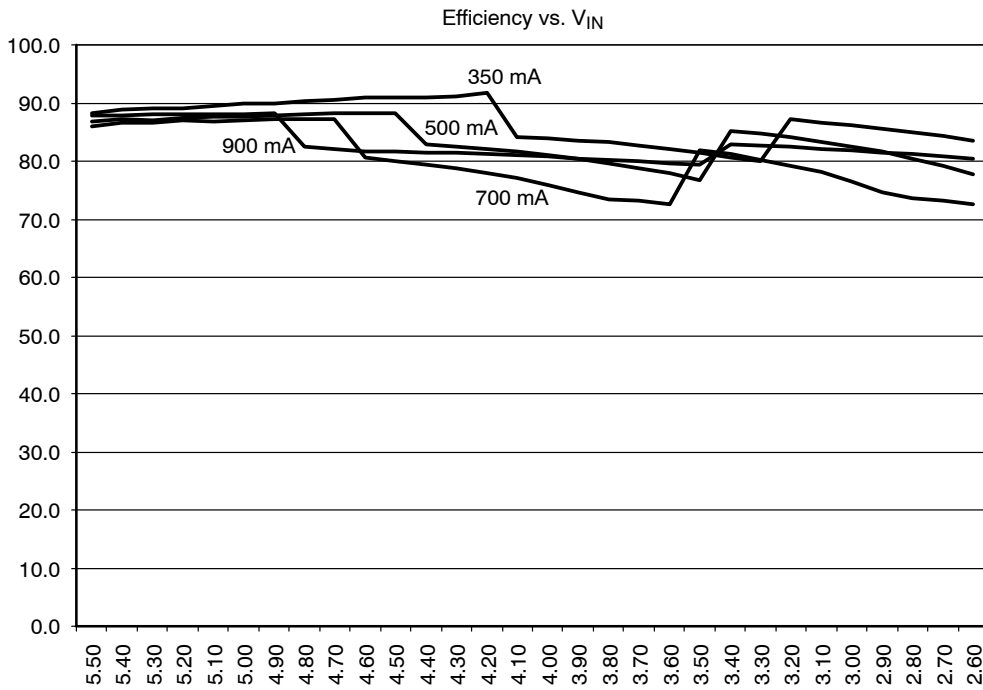

Figure 3. Efficiency vs. Input Voltage, $R_{pca} = 82\text{ K}\Omega$, load = LXHL - PW09, Inductor = VLF5014A4R7M1R1 for $I_{out} = 350\text{ mA}$, 500 mA and 700 mA , RLF7030T4R7M3R4 for $I_{out} = 900\text{ mA}$

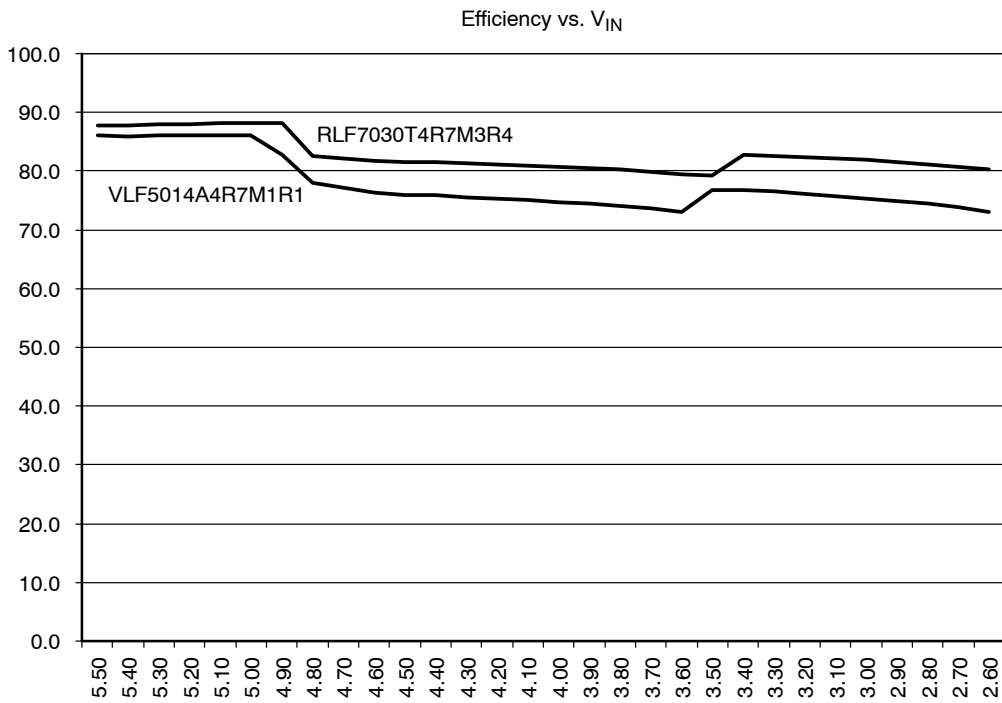

Figure 4. Efficiency vs. Input Voltage @ Inductor, $I_{out} = 900\text{ mA}$, $R_{pca} = 82\text{ K}\Omega$, load = LXHL - PW09, $V_f = 3.9\text{ V}$

NCP5030MTTXGEVB

Output Current Regulation

Figure 5 shows the relationship between output current regulation R_{pca} and input voltage. There may be a tradeoff between output current and input current limit.

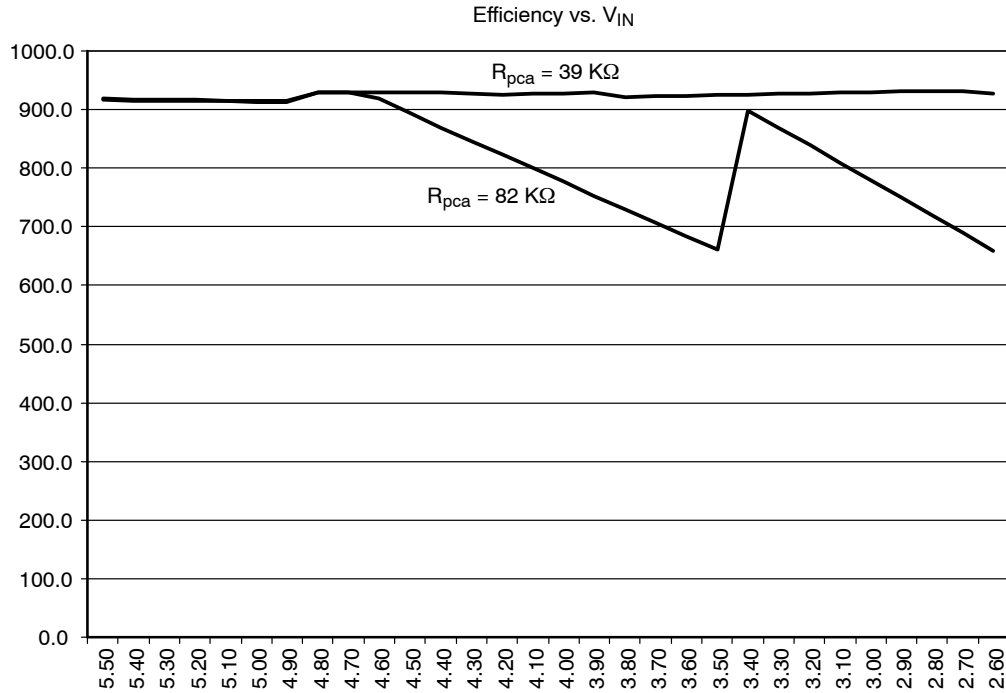

Figure 5. Output Current Regulation vs. Input Voltage @ R_{pca} , $I_{out} = 900\text{ mA}$
Inductor = RLF7030T4R7M3R4; Load = LXHL - PW09, $V_f = 3.9\text{ V}$

NCP5030MTTXGEVB

PCB LAYOUT

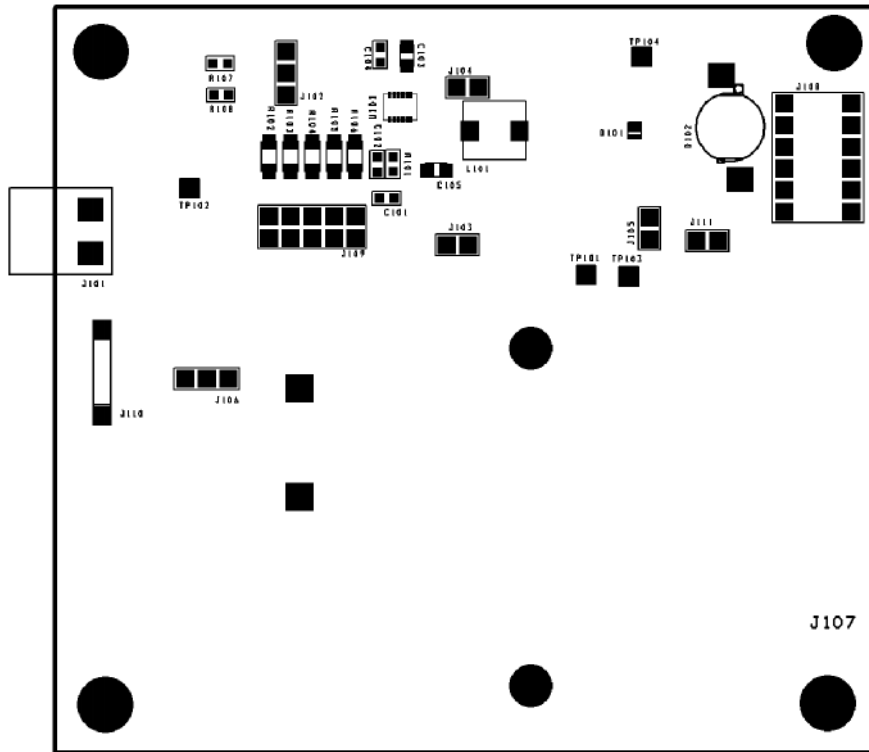

Figure 6. Assembly Layer

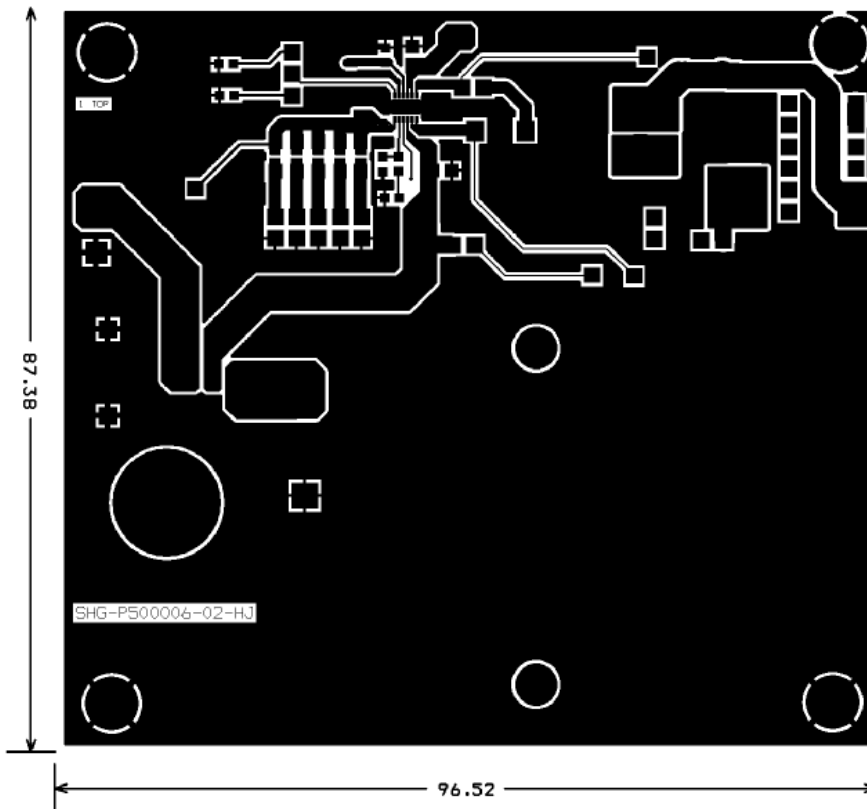

Figure 7. Top Layer Routing

NCP5030MTTXGEVB

BILL OF MATERIALS

Table 6. BILL OF MATERIALS FOR THE NCP5030MTTXGEVB HIGH POWER LIGHTING EVALUATION BOARD

Designator	Qty	Description	Value	Tolerance	Footprint	MFG	MFG Part Number	Substitution Allowed	ROHS Compliant
C101	1	Ceramic chip capacitor	330 pF	5%	0603	TDK	C1608C0G1H331J	Yes	Yes
C102	1	Ceramic chip capacitor	22 pF	5%	0603	TDK	C1608C0G1H220J	Yes	Yes
C103	1	Ceramic chip capacitor	22 μF	20%	0805	TDK	C2012X5R0J226M	Yes	Yes
C104	1	Ceramic chip capacitor	1 μF	20%	0603	TDK	C1608X5R0J105M	Yes	Yes
C105	1	Ceramic chip capacitor	10 μF	20%	0805	TDK	C2012X5R0J106M	Yes	Yes
L101	1	Chip winding magnetic shielded inductor	4.7 μH	20%	4.5*4.7 mm	TDK	VLF5014AT-4R7M1R1	Yes	Yes
					6.8*7.3 mm		RLF7030T-4R7M3R4		
R101	1	Chip resistor	100 KΩ	5%	0603	Std.	Std.	Yes	Yes
R102	1	Chip resistor	TBD (not mounted)	NA	0805/1206	Std.	NA	NA	NA
R103, R104	2	Chip resistor	0.51 Ω	1%,1/4 W	0805/1206	Std.	Std.	Yes	Yes
R105	1	Chip resistor	1 Ω	1%,1/8 W	0805/1206	Std.	Std.	Yes	Yes
R106	1	Chip resistor	2.2 Ω	1%,1/8 W	0805/1206	Std.	Std.	Yes	Yes
R107	1	Chip resistor	39 KΩ	5%	0603	Std.	Std.	Yes	Yes
R108	1	Chip resistor	82 KΩ	5%	0603	Std.	Std.	Yes	Yes
TP101-TP104	4	PCB terminal 1 mm	NA	NA	Standard 1 mm	Std.	Std.	Yes	Yes
U101	1	Buck-Boost driver for high power flash LED	NA	NA	WDFN12, 3*4 mm		NCP5030MTTXG	No	Yes
						ON Semiconductor			
J101	1	Header X 2	NA	NA	SL5.08/2/90	SL5.08/2/90B	Weidmüller	Yes	Yes
J102, J106	2	Header 3 pin, 0.1 inch spacing	NA	NA	0.100*3	Std.	Std.	Yes	Yes
J103, J104, J105, J111	4	Header 2 pin, 0.1 inch spacing	NA	NA	0.100*2	Std.	Std.	Yes	Yes
J107	1	3*AA Battery holder	NA	NA	1.84*2.25 mm	MPD	BH3AA-PC	No	Yes
J108	1	Header 6	NA	NA	0.100*6	AMP	535676	No	Yes
J109	1	Header 2*5,0.1 inch spacing	NA	NA	0.100*2*5	Std.	Std.	Yes	Yes
J110	1	GND jumper 400 mil spacing	NA	NA	0.400 spacing	D3082-B01	Harwin	Yes	Yes
D101	1	LXCL-PWT1	NA	NA	2.0*1.6 mm	Lumileds	LXCL-PWT1	No	Yes
D102	1	Lambertian LED modules	LUXEON I LUXEON III	NA	Lambertian	Lumileds	LXHL-PW01 LXHL-PW09	Yes	Yes

NCP5030MTTXGEVB

TEST PROCEDURE

1. Visual inspection the board after solder, there should be no short, redundant solder ball.
2. Measure the resistance of each pin of NCP5030 to GND, there should be no short to GND (except pin GND) or each other. Measure the forward and backward resistance of D101/D102. Ensure solder is good.
3. Short J104;
4. Short J103;
5. Short J106 2–3(power supply from J101);
6. Configure J102 in 2–3 position;
7. Short J105, open J111, J108;
8. Configure J109 in 100 mA position (pin1–2 shorted);
9. Configure power supply output voltage to 3.7 V.
10. Power off and connect power supply to J101;
11. Power on, check D101 is lighting;
12. Power off and Configure J109 in 200 mA position (pin3–4 shorted);
13. Power on, check D101 is lighting;
14. Power off and Configure J109 in 400 mA position (pin5–6 shorted);
15. Power on, check D101 is lighting;
16. Power off and Configure J109 in 400 mA position (pin7–8 shorted);
17. Power on, check D101 is lighting;
18. Power off and configure J102 at 1–2 position;
19. Configure J109 in 100 mA position (pin1–2 shorted);
20. Power on, check D101 is lighting;
21. Power off, open J105, short J111 (if D102 mounted);
22. Power on, check D102 is lighting (if D102 mounted);
23. Power off, open J105, J111, connect J108 to external LED or LED module (if there is);
24. Power on, check external LED or LED module is lighting (if there is);
25. Power off;
26. Configure board default and connect jumpers accordingly
 - Place board in 300 mA output current configuration:
 - Place jumpers on J109 1–2(100 mA), 3–4(200 mA), 9–10(0 mA);
 - Place a jumper on J102 2–3;
 - Place jumpers on J103/J104;
 - Place a jumper on J105 and make sure J111 is open;
 - Place a jumper on J106 2–3;

ON Semiconductor and  are registered trademarks of Semiconductor Components Industries, LLC (SCILLC). SCILLC reserves the right to make changes without further notice to any products herein. SCILLC makes no warranty, representation or guarantee regarding the suitability of its products for any particular purpose, nor does SCILLC assume any liability arising out of the application or use of any product or circuit, and specifically disclaims any and all liability, including without limitation special, consequential or incidental damages. "Typical" parameters which may be provided in SCILLC data sheets and/or specifications can and do vary in different applications and actual performance may vary over time. All operating parameters, including "Typicals" must be validated for each customer application by customer's technical experts. SCILLC does not convey any license under its patent rights nor the rights of others. SCILLC products are not designed, intended, or authorized for use as components in systems intended for surgical implant into the body, or other applications intended to support or sustain life, or for any other application in which the failure of the SCILLC product could create a situation where personal injury or death may occur. Should Buyer purchase or use SCILLC products for any such unintended or unauthorized application, Buyer shall indemnify and hold SCILLC and its officers, employees, subsidiaries, affiliates, and distributors harmless against all claims, costs, damages, and expenses, and reasonable attorney fees arising out of, directly or indirectly, any claim of personal injury or death associated with such unintended or unauthorized use, even if such claim alleges that SCILLC was negligent regarding the design or manufacture of the part. SCILLC is an Equal Opportunity/Affirmative Action Employer. This literature is subject to all applicable copyright laws and is not for resale in any manner.

PUBLICATION ORDERING INFORMATION

LITERATURE FULFILLMENT:

Literature Distribution Center for ON Semiconductor
P.O. Box 5163, Denver, Colorado 80217 USA
Phone: 303-675-2175 or 800-344-3860 Toll Free USA/Canada
Fax: 303-675-2176 or 800-344-3867 Toll Free USA/Canada
Email: orderlit@onsemi.com

N. American Technical Support: 800-282-9855 Toll Free
USA/Canada
Europe, Middle East and Africa Technical Support:
Phone: 421 33 790 2910
Japan Customer Focus Center
Phone: 81-3-5817-1050

ON Semiconductor Website: www.onsemi.com

Order Literature: <http://www.onsemi.com/orderlit>

For additional information, please contact your local Sales Representative